

Push and Pull Door Furniture

Push and Pull Door Furniture

184 Offset Pull

Made from brass and designed to compliment 1800 and 2800 Series Brass Plate Furniture, the 184 Offset Pull provides a fixed pull without impacting the cylinder/turn functionality or the design aesthetic of a plate furniture installation.

Application

Designed for use with Lockwood 3570 Synergy and 3P70 Pentagon Series Mortice Locks using Lockwood 1800 or 2800 Series Brass Plate Furniture.

Recommended for Access Control doors with electric strikes.

Compliance

 DISABLED ACCESS – AS1428.1 ✓

Dimensions

Length:	163.5mm
Diameter:	16mm
Projection:	61mm
Screw Centres:	147.5mm
Finger Clearance:	45mm

Fixing

The 184 Pull is designed with 147.5mm screw centres to enable it to be fixed through a standard visible fix brass plate (1900 or 2900).

Plates are to be ordered separately to the 184 and care should be taken to ensure that a visible fix plate is specified for both sides of the door.

Finishes

Satin Chrome Brushed	SC
Chrome Plate	CP



Push and Pull Door Furniture

194 Series Round End Push and Pull Plates

Made from brass and supplied completely assembled with handles if applicable. "PUSH" or "PULL" plates are engraved with 16mm high letters.

Application

Brass Push and Pull Handle Door Furniture for public, commercial and industrial buildings.

Compliance

 **DISABLED ACCESS – AS1428.1** ✓

Dimensions

Length: 255mm
 Width: 52mm
 Thickness: 10mm
 Diameter: 17.5mm
 Finger Clearance: 43mm

Fixing

Plates are designed to fit back to back. The external plate is supplied with concealed fixings and therefore must be used with an internal plate which has visible fixings.

Finishes

The 194 Series is only available in the following finishes:

Chrome Plate	CP
Polished Brass	PB
Satin Chrome Brushed	SC

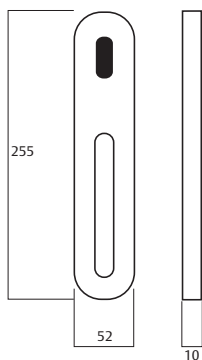

Plate Options for 194 Pull Plate with 'P2' Pulls

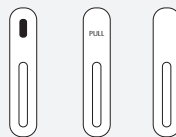
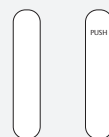



Plate Options for 194 Pull Plate with 'P3' Pulls



Plate Options for 194 Push Plate



Plates and Functions Legend

Cylinder Hole 

Push and Pull Door Furniture

206/207 Series Push and Pull Plates



ASSA ABLOY

Application

The 206/207 Series Door Furniture are 2mm thick stainless steel plates with 10mm radius corners. Concealed fixed plates have studs with internal threads located in each corner, visible plates have corresponding countersunk holes and are fixed back to back through the door.

Designed for use with Lockwood 3570 Synergy and 3P70 Pentagon Series Mortice Locks.

Compliance

DISABLED ACCESS – AS1428.1 ✓

Dimensions

Length:	250mm
Width:	200mm
Thickness:	2mm
Handle Diameter:	17.5mm
Finger Clearance:	40mm

Materials

Stainless steel.

Door Thickness

35 to 45mm standard. For doors 45 to 55mm thick, specify long fixing screws SP2000-208.

Finishes

Satin Stainless Steel	SS
Powdercoat	PC
Polished Stainless Steel	PS



Plates

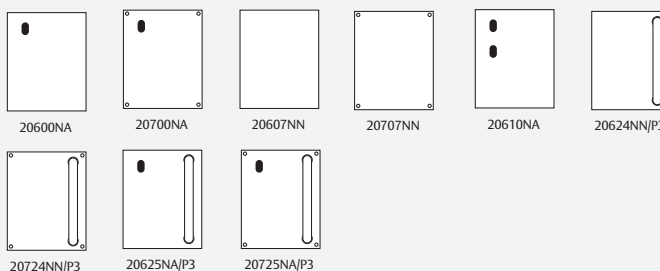

Legend

Cylinder Hole		Slotted Button		LED	
Turn-Snib		Disabled		Indicating Slotted Button	

D Handle Selections



Brass or Stainless Steel 17.5mm

P3

Centres

203mm

Push and Pull Door Furniture

208/209 Series Push and Pull Plates

Application

The 208/209 Series Door Furniture are 2mm thick stainless steel or brass plates with 10mm radius corners. Concealed fixed plates have studs with internal threads located in each corner, visible plates have corresponding countersunk holes and are fixed back to back through the door.

Designed for use with Lockwood 3570 Synergy and 3P70 Pentagon Series Mortice Locks.

Compliance

 **DISABLED ACCESS – AS1428.1** ✓

Dimensions

Length:	324mm
Width:	162mm
Thickness:	2mm
Handle Diameter:	17.5mm
Finger Clearance:	40mm

Materials

Stainless steel.

Door Thickness

35 to 45mm standard. For doors 45 to 55mm thick, specify long fixing screws SP2000-208.

Finishes

Satin Stainless Steel	SS
Powdercoat	PC
Polished Stainless Steel	PS



Plates

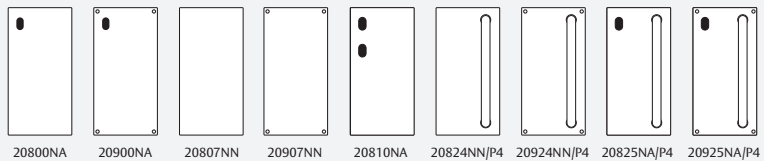

Legend

Cylinder Hole		Slotted Button		LED	
Turn-Snib		Disabled		Indicating Slotted Button	

D Handle Selections

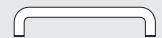

Brass or Stainless Steel 17.5mm

P4

Centres

250mm

Push and Pull Door Furniture

214/215 Series 10mm Radius Corner

Push and Pull Plates

Application

The 214 Series Door Furniture is 300 x 100 x 2mm thick stainless steel or brass plates with 10mm radius corners. Concealed fixed plates have studs with internal threads located in each corner, visible plates have corresponding countersunk holes and are fixed back to back through the door.

Designed for use with Lockwood 3570 Synergy and 3P70 Pentagon Series Mortice Locks.

Compliance

DISABLED ACCESS – AS1428.1 ✓

Dimensions

Length:	300mm
Width:	100mm
Thickness:	2mm
Handle Diameter:	17.5mm
Finger Clearance:	40mm

Materials

Stainless steel or brass.

Door Thickness

35 to 45mm standard. For doors 45 to 55mm thick, specify long fixing screws SP2000-208.

Finishes

Satin Stainless Steel	SS
Polished Stainless Steel	PS
Powdercoat	PC
Polished Brass	PB

Function/Handle Selection

Certain functions require certain handles to be used. The following table outlines which length handles (screw centre distance shown) should be used for a given function.

Function	Description	No Engraving	With Engraving
24	Pull Handle Only	P4	P3
25	Pull Handle and Cylinder	P2	P2
26	Pull Handle and Emergency Turn	P2	P2
27	Pull Handle and Turn Knob	P2	P2
28	Pull Handle and Privacy Indicator Emergency Turn	P2	P2
29	Pull Handle and Privacy Indicator Turn Knob	P2	P2
30	Pull Handle and Dual Cylinder	x	x
42	Pull Handle and Disabled Turn	P2	P1
44	Pull Handle Only – Offset from Bottom	P1	x

Note: x indicates this function is not available in this configuration.



Plates

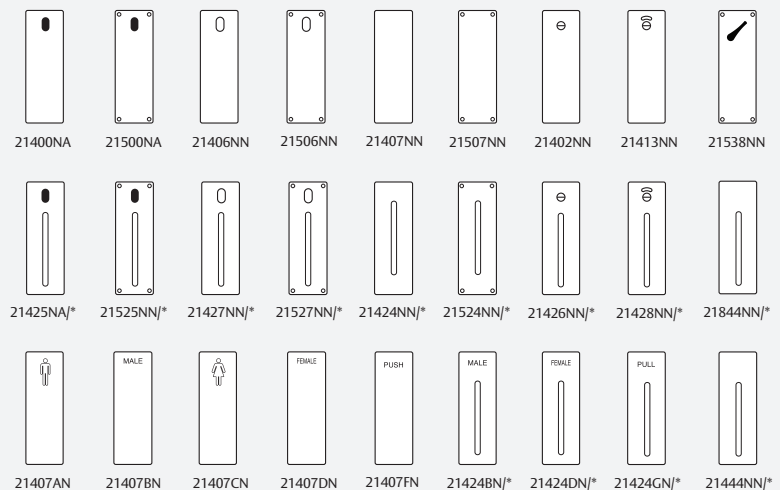

Legend

Cylinder Hole		Slotted Button		LED	
Turn-Snib		Disabled		Indicating Slotted Button	

D Handle Selections

17.5mm Handle	P1	P2	P3	P4
Centres	108mm	152mm	203mm	250mm

Push and Pull Door Furniture

216/217 Series 10mm Radius Corner Push and Pull Plates

Application

The 216 Series Door Furniture is 300 x 65 x 2mm thick stainless steel or brass plate with 10mm radius corners. Concealed fixed plates have studs with internal threads located in each corner, visible plates have corresponding countersunk holes and are fixed back to back through the door.

Designed for use with Lockwood 3570 Synergy and 3P70 Pentagon Series Mortice Locks.

Compliance

 **DISABLED ACCESS – AS1428.1** ✓

Dimensions

Length:	300mm
Width:	65mm
Thickness:	2mm
Handle Diameter:	17.5mm
Finger Clearance:	40mm

Materials

Stainless steel or brass.

Door Thickness

35 to 45mm standard. For doors 45 to 55mm thick, specify long fixing screws SP2000-208.

Finishes

Satin Stainless Steel	SS
Polished Stainless Steel	PS
Powdercoat	PC
Polished Brass	PB

Function/Handle Selection

Certain functions require certain handles to be used. The following table outlines which length handles (screw centre distance shown) should be used for a given function.

Function	Description	No Engraving	With Engraving
24	Pull Handle Only	P4	P3
25	Pull Handle and Cylinder	P2	P2
26	Pull Handle and Emergency Turn	P2	P2
27	Pull Handle and Turn Knob	P2	P2
28	Pull Handle and Privacy Indicator Emergency Turn	P2	P2
29	Pull Handle and Privacy Indicator Turn Knob	P2	P2
30	Pull Handle and Dual Cylinder	x	x
42	Pull Handle and Disabled Turn	P2	P2
44	Pull Handle Only – Offset from Bottom	P1 P2	x





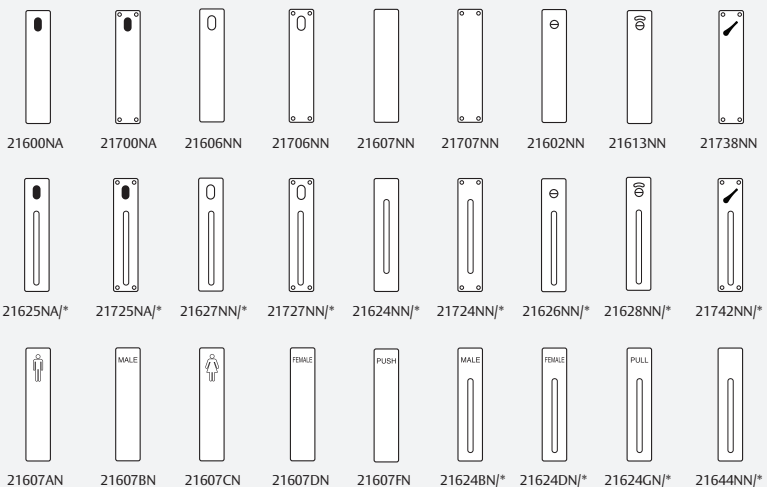

Note: x indicates this function is not available in this configuration.



Plates



Legend

Cylinder Hole		Slotted Button		LED	
Turn-Snib		Disabled		Indicating Slotted Button	

D Handle Selections

17.5mm Handle	P1	P2	P3	P4
Centres	108mm	152mm	203mm	250mm

Push and Pull Door Furniture

218/219 Series 10mm Radius Corner Push and Pull Plates

Application

The 218 Series Door Furniture is 250 x 50 x 2mm thick stainless steel or brass with 10mm radius corners. Concealed fixed plates have studs with internal threads located in each corner, visible fixed plates have corresponding countersunk holes and are fixed back to back through the door.

Designed for use with Lockwood 3570 Synergy and 3P70 Pentagon Series Mortice Locks.

Compliance

DISABLED ACCESS – AS1428.1 ✓

Dimensions

Length:	250mm
Width:	50mm
Thickness:	2mm
Handle Diameter:	17.5mm
Finger Clearance:	40mm

Materials

Stainless steel or brass.

Door Thickness

35 to 45mm standard. For doors 45 to 55mm thick, specify long fixing screws SP2000-208.

Engraving

Options are available as indicated on the right.

Finishes

Satin Stainless Steel	SS
Polished Stainless Steel	PS
Powdercoat	PC
Polished Brass	PB

Function/Handle Selection

Certain functions require certain handles to be used. The following table outlines which length handles (screw centre distance shown) should be used for a given function.

Function	Description	No Engraving	With Engraving
24	Pull Handle Only	P3	P2
25	Pull Handle and Cylinder	P1	P1
26	Pull Handle and Emergency Turn	P1	P1
27	Pull Handle and Turn Knob	P1	P1
28	Pull Handle and Privacy Indicator Emergency Turn	P1	P1
29	Pull Handle and Privacy Indicator Turn Knob	P1	P1
30	Pull Handle and Dual Cylinder	x	x
42	Pull Handle and Disabled Turn	P1	P1
44	Pull Handle Only – Offset from Bottom	P1 P2	x

Note: x indicates this function is not available in this configuration.

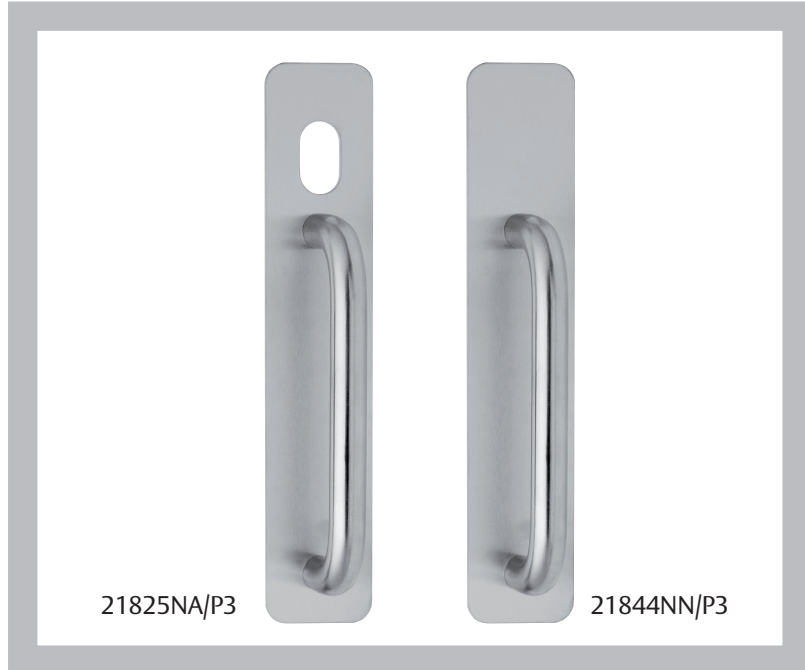

Plates

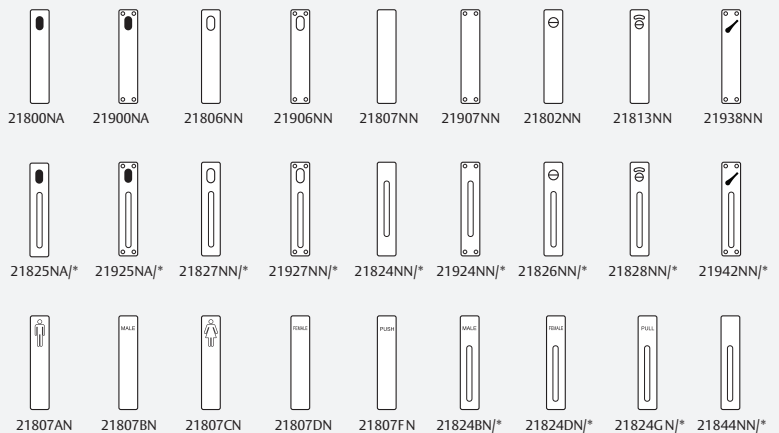

Legend

Cylinder Hole		Slotted Button		LED	
Turn-Snib		Disabled		Indicating Slotted Button	

D Handle Selections

17.5mm Handle	P1	P2	P3
Centres	108mm	152mm	203mm

Push and Pull Door Furniture

Pull Handles



ASSA ABLOY

All pull handles are designed for single handle application and can be used with Lockwood Pull Plates and Roses.

Features and Specifications

AS14281.1 Compliance

Fixing

Handles are concealed fixed. If ordered with Lockwood Pull Plates or Roses, handles are screw fixed to plates.

Materials

Brass and stainless steel.



Image for illustration only

Limiting Dimensions

Handle Number	Length	Diameter	Projection	Fixing Centres	Finger Clearance	Brass	Stainless Steel	Old Handle
P1	125	17.5	54	108	40	✓	✓	05, 16
P2	170	17.5	54	152	40	✓	✓	07, 17
P3	220	17.5	54	203	40	✓	✓	08, 18
P4	267	17.5	54	250	40	✓	✓	19
B2	170	17.5	49	152	43	✓	-	07, 17
B3	220	17.5	49	203	43	✓	-	08, 18
B4	267	17.5	49	250	43	✓	-	19

Limiting Dimensions

Handle Number	Length	Diameter	Projection	Fixing Centres	Finger Clearance
38	248	16	Base: 54	152	38
Top: 73					

Designed for single handle applications for hospitals, disabled and aged care facilities. Material -solid brass.



Push and Pull Door Furniture

Lockwood Entrance Handles



ASSA ABLOY

141

Dimensions:

	A	B1	B2	C	D	E
141X300SSS	300mm	22mm	40mm	45mm	450mm	25mm
141X450SSS	450mm	22mm	40mm	45mm	600mm	25mm
141X600SSS*	600mm	22mm	40mm	45mm	750mm	25mm

* Pictured

Fixing:

Timber 2 x 80mm M8 Bolts - 8.5mm hole

Glass 2 x 40mm M8 Bolts - 13mm hole

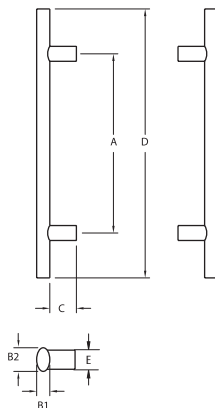

142

Dimensions:

	A	B	C	D	E
142X300SSS	300mm	32mm	45mm	450mm	25mm
142X450SSS	450mm	32mm	45mm	600mm	25mm
142X600SSS*	600mm	32mm	45mm	750mm	25mm

* Pictured

Fixing:

Timber 2 x 80mm M8 Bolts - 8.5mm hole

Glass 2 x 40mm M8 Bolts - 13mm hole

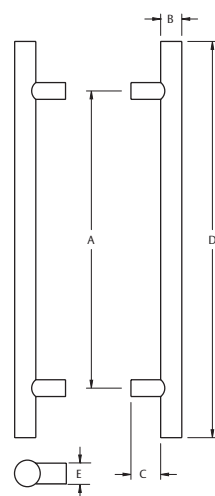

143

Dimensions:

	A	B1	B2	C	D
143X300SSS	300mm	30mm	15mm	35mm	315mm
143X450SSS	450mm	30mm	15mm	35mm	465mm
143X600SSS*	600mm	30mm	15mm	35mm	615mm

* Pictured

Fixing:

Timber 2 x 62mm M6 Bolts - 8.5mm hole

Glass 2 x 32mm M6 Bolts - 13mm hole

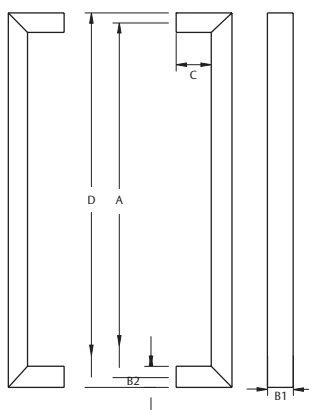

Push and Pull Door Furniture

Lockwood Entrance Handles

145

Dimensions:

	A	B	C	D	E
145X225SSS	225mm	25mm	45mm	300mm	19mm
145X375SSS	375mm	25mm	45mm	450mm	19mm
145X525SSS*	525mm	25mm	45mm	600mm	19mm

* Pictured

Fixing:

Timber 2 x 70mm M8 Bolts - 8.5mm hole

Glass 2 x 30mm M8 Bolts - 13mm hole

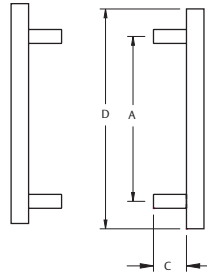

146

Dimensions:

	A	B	C	D	E	F
146X450SSS	450mm	25mm	60mm	475mm	60mm	25mm
146X600SSS*	600mm	25mm	60mm	625mm	60mm	25mm

* Pictured

Fixing:

Timber 2 x 80mm M8 Bolts - 8.5mm hole

Glass 2 x 40mm M8 Bolts - 13mm hole

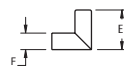
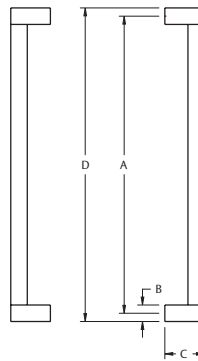

147

Dimensions:

	A	B	C	D	E
147X450SSS	450mm	19mm	45mm	600mm	19mm

Fixing:

Timber 2 x 62mm M8 Bolts - 8.5mm hole

Glass 2 x 32mm M8 Bolts - 13mm hole

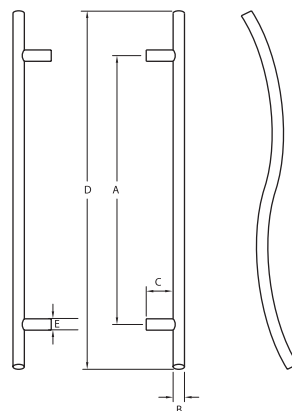

Push and Pull Door Furniture

Lockwood Entrance Handles



ASSA ABLOY

151

Dimensions:

	A	B	C	D	E
151X3000SSS	300mm	32mm	80mm	332mm	200mm

Fixing:

Timber	2 x 80mm M8 Bolts - 8.5mm hole
Glass	2 x 40mm M8 Bolts - 13mm hole

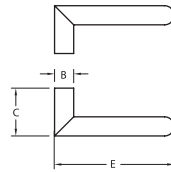
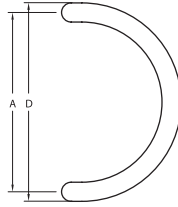

192

Dimensions:

	A	B	C	D
192X450SSS	450mm	32mm	85mm	482mm
192X600SSS	600mm	32mm	85mm	632mm

Fixing:

Timber	2 x 80mm M8 Bolts - 8.5mm hole
Glass	2 x 40mm M8 Bolts - 13mm hole

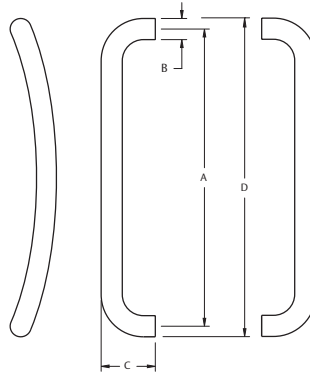

231

Dimensions:

	A	B	C	D	E
231X3000SSS	300mm	32mm	85mm	332mm	140mm

Fixing:

Timber	2 x 80mm M8 Bolts - 8.5mm hole
Glass	2 x 40mm M8 Bolts - 13mm hole

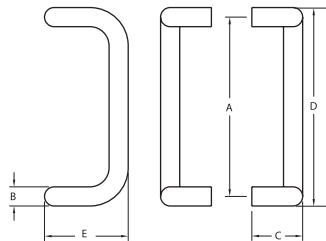

Push and Pull Door Furniture Flush Pulls



ASSA ABLOY

Features and Specifications

- Zinc alloy cast flush pulls
- Available in a range of three sizes and three finishes
- Display packed, complete with fixing screws



Product	Dimensions	Finishes	Packaging	Part Number
L609	85 x 30mm	Chrome Plate	Display pack	L609CPDP
		Polished Brass Plate	Display pack	L609PBPD
		Satin Chrome Pearl	Display pack	L609SPDP

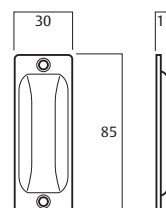

Product	Dimensions	Finishes	Packaging	Part Number
L611	115 x 35mm	Chrome Plate	Display pack	L611CPDP
		Polished Brass Plate	Display pack	L611PBPD
		Satin Chrome Pearl	Display pack	L611SPDP

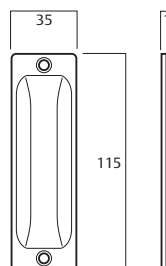

Product	Dimensions	Finishes	Packaging	Part Number
L610	145 x 40mm	Chrome Plate	Display pack	L610CPDP
		Polished Brass Plate	Display pack	L610PBPD
		Satin Chrome Pearl	Display pack	L610SPDP

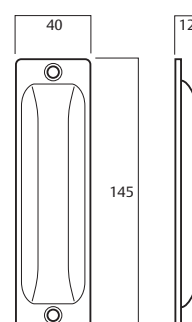

Push and Pull Door Furniture Handles

Cast Brass Handle

- Cast brass handle, visible fixing
- Display packed, complete with fixing screws

Product	Length	Finishes	Packaging	Part Number
L9-150	150mm	Chrome Plate	Display pack	L9-150CPDP
		Satin Chrome Pearl	Display pack	L9-150SPDP



Extruded Brass Handle

- Extruded brass handle, concealed fixing
- Display packed, complete with fixing screws

Product	Length	Finishes	Packaging	Part Number
L70	100mm	Satin Chrome Pearl	Display pack	L70SPDP

