



Plate Door Furniture

# Plate Door Furniture

## 1800 Series Square End Plate Furniture

For a smart look choose this rectangular plate with bevelled edges and corners. It features concealed fixing on the outside plate.

### Application

Designed for use with the Lockwood Synergy & Pentagon Series Mortice Locks and Latches.

### Features and Specifications

#### Handing

Plates are not handed; lever may be reversed by removing stop screw, except those denoted by\*:

#### Dimensions

166 x 48 x 12mm

#### Fixing

Plates are designed to fit back to back. If outside plate is specified with concealed fixing, then the inside plate must be visible fixed.

#### Door Thickness

External plates are supplied with fixing screws to suit door thickness between 32 and 50mm.

#### Turn Functions

Turn functions feature a unique mechanism that automatically adjusts the length of the tail bar to suit a particular door thickness. Turn functions may be used directly with a Pentagon Series Mortice Lock without the need for a turn adaptor to be installed in the lock (excludes anti vandal applications).

### Finishes

#### Standard

Satin Chrome Brushed SC

#### Non Standard

Chrome Plate CP

Polished Brass PB

Polyester Powdercoat PC

Other finishes on application.

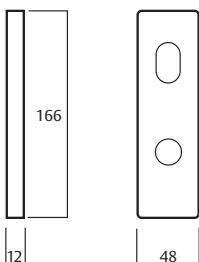

### Levers and Knobs to Suit

For detailed information regarding brass levers refer to page 3.100

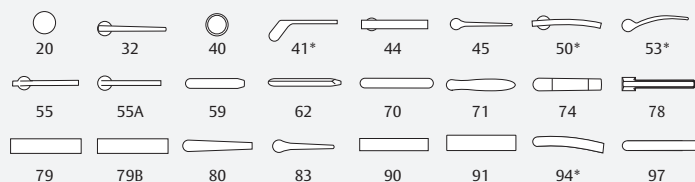

\* Denotes handed levers

### Plates and Functions

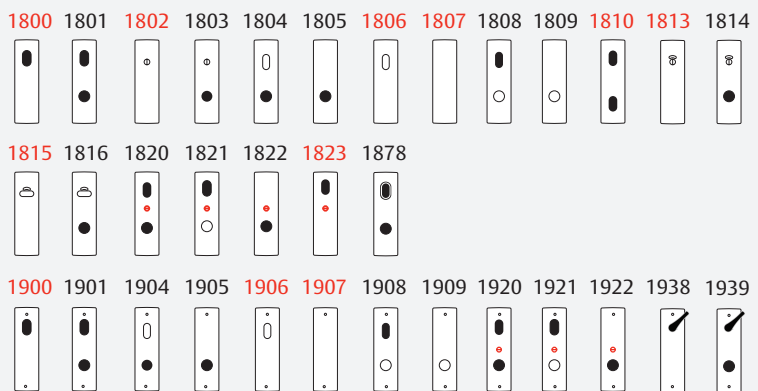

Plate Numbers marked red indicate no lever option

#### Plates and Functions Legend

Cylinder Hole		Fixed Lever		Indicating Turnknob	
Turnknob		Disabled		Indicating Slotted Turn	
Slotted Turn		LED		Lever	

# Plate Door Furniture

## 2800 Series Round End Plate Furniture



A beautifully curved brass plate with bevelled edges and the benefit of concealed fixing on the external plate.

### Application

Designed for use with Lockwood Synergy & Pentagon Series Mortice Locks and Latches.

### Features and Specifications

#### Handing

Plates are not handed, lever may be reversed by removing stop screw, except those denoted by\*:

#### Dimensions

166 x 48 x 12mm

#### Fixing

Plates are designed to fit back to back. If outside plate is specified with concealed fixing, then the inside plate must be visible fixed.

#### Door Thickness

External plates are supplied with fixing screws to suit door thickness between 32 and 50mm.

#### Turn Functions

Turn functions feature a unique mechanism that automatically adjusts the length of the tail bar to suit a particular door thickness. Turn functions may be used directly with a Pentagon Series Mortice Lock without the need for a turn adaptor to be installed in the lock (excludes anti vandal applications).

### Finishes

#### Standard

Satin Chrome Brushed SC

#### Non Standard

Chrome Plate CP

Polished Brass PB

Polyester Powdercoat PC

Other finishes on application.

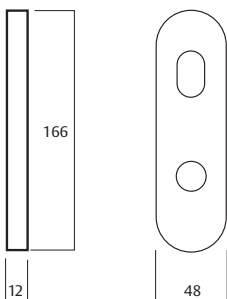

### Levers and Knobs to Suit

For detailed information regarding brass levers refer to page 3.100

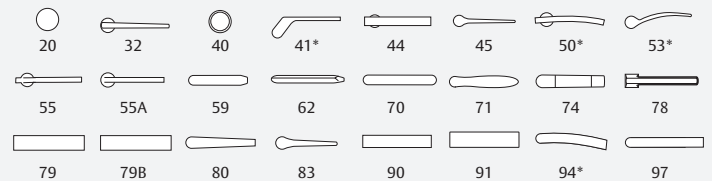

\* Denotes handed levers

### Plates and Functions

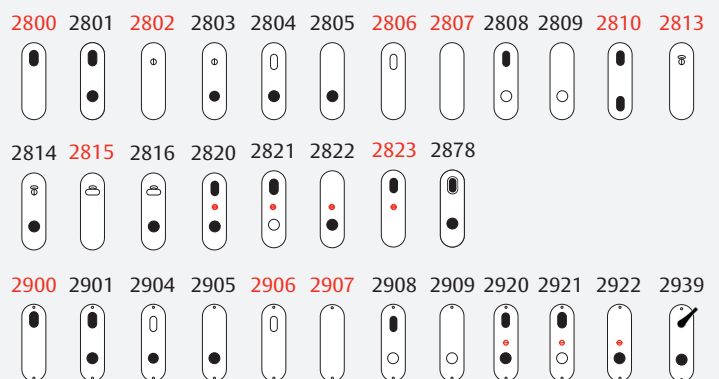

Plate numbers marked red indicate no lever option

#### Plates and Functions Legend

Cylinder Hole		Fixed Lever		Indicating Turnknob	
Turnknob		Disabled		Indicating Slotted Turn	
Slotted Turn		LED		Lever	



# Plate Door Furniture

## Proximity Furniture

Easy to install and operate, Lockwood Proximity Furniture is available in a wide range of stylish levers and finishes to enhance any contemporary building design, bringing a new dimension to commercial security locking solutions.

### Proximity Mortice Lock Specifications

- Multivoltage 12 24VDC
- Field selectable fail safe/fail secure
- 60mm backset only

### Monitoring

The following monitoring features are standard:

- Dual key override
- Deadlatched and locked
- Door closed
- Request to exit

### Proximity Reader Specifications

- HID 125KHz proximity reader
- Wiegand data output
- Supply voltage: 5 12VDC
- Current requirements (stand by/peak)  
25/90mA @ 5VDC, 15/125mA @ 12VDC
- Beeper activated when presenting proximity card
- Red/green led indication of reader/lock status

For details refer to 5.44



# Plate Door Furniture

## 4800 Series Narrow Stile Plate Furniture

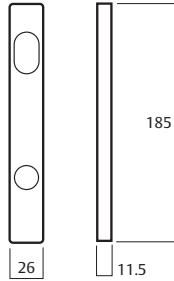

A slimline, rectangular brass plate that adds style to your choice of lever.

### Application

Designed for use with Lockwood 3570 Synergy Series and 3P70 Pentagon Series Mortice Latches (4600/4700) and 3580 Series Synergy and 3P80 Pentagon Mortice Latches (4800/4900)

**Note:** certain lever designs are not compatible on short backset assemblies due to interference with the door stop. Refer to page 3.80 for lever/backset suitability on 4800/4900 Series Plates.

### Features and Specifications

#### Dimensions

185 x 26 x 11.5mm

#### Fixing

Plates are designed to fit back to back. If outside plate is specified with concealed fixing, then the inside plate must be visible fixed. All lever handles are reversible, except those denoted by\*.

#### Door Thickness

External plates are supplied with fixing screws to suit door thickness between 32 and 50mm. Refer to lockweb.com.au for information on fixing screw and spindle options for thicker doors.

### Levers to Suit

For detailed information regarding brass levers refer to page 3.100

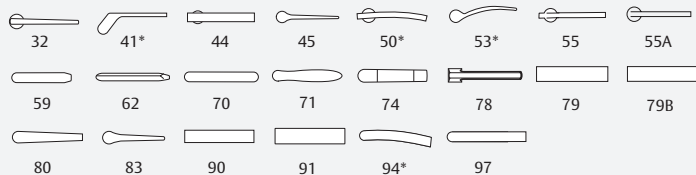

### 4800/4900 Plates and Functions (3580 Series)

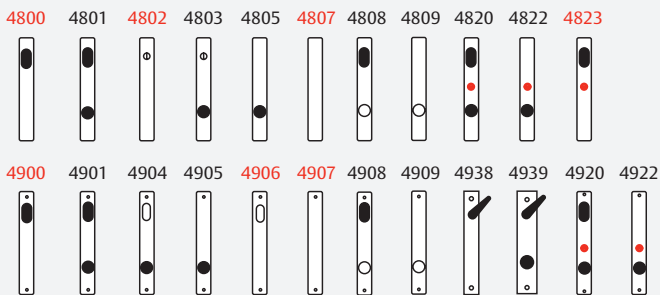

### 4600/4700 Plates and Functions (3570 Series)

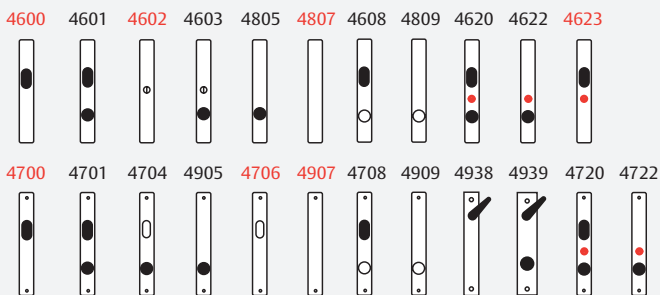

#### Plates and Functions Legend

Cylinder Hole		Fixed Lever		Indicating Turnknob	
Turnknob		Disabled Accessible		Indicating Slotted Turn	
Slotted Turn		LED		Lever	

\* Denotes handed levers

Plate numbers marked **red** indicate no lever option



# Plate Door Furniture

## 5800 Series Narrow Stile Plate Furniture



ASSA ABLOY

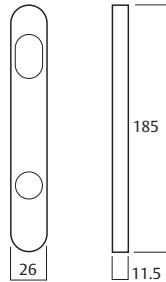

Functional, yet elegant, the soft lines of this round ended brass plate complement a wide range of levers.

### Application

Designed for use with Lockwood 3570 Synergy Series and 3P70 Pentagon Series Mortice Latches (4600/4700) and 3580 Series Synergy and 3P80 Pentagon Mortice Latches (4800/4900)

**Note:** certain lever designs are not compatible on short backset assemblies due to interference with the door stop. Refer to page 3.80 for lever/backset suitability on 4800/4900 Series Plates.

### Features and Specifications

#### Dimensions

185 x 26 x 11.5mm

#### Fixing

Plates are designed to fit back to back. If outside plate is specified with concealed fixing, then the inside plate must be visible fixed. All lever handles are reversible, except those denoted by \*.

#### Door Thickness

External plates are supplied with fixing screws to suit door thickness between 32 and 50mm. Refer to lockweb.com.au for information on fixing screw and spindle options for thicker doors.

### Levers to Suit

For detailed information regarding brass levers refer to page 3.100

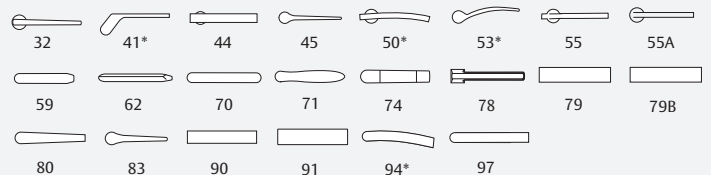

### 5800/5900 Plates and Functions (3580 Series)

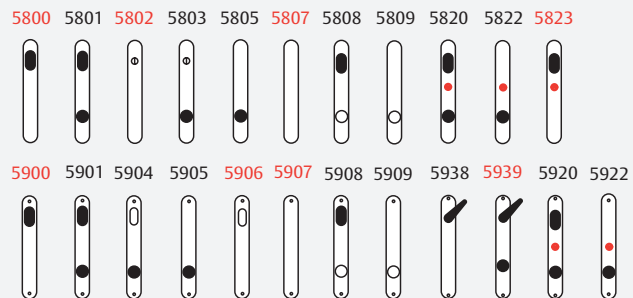

### 5600/5700 Plates and Functions (3570 Series)

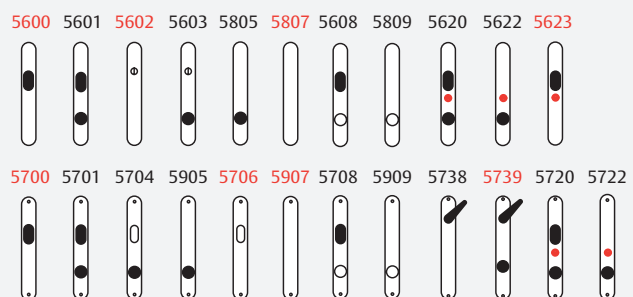

#### Plates and Functions Legend

Cylinder Hole		Fixed Lever		Indicating Turnknob	
Turnknob		Disabled Accessible		Indicating Slotted Turn	
Slotted Turn		LED		Lever	



\* Denotes handed levers

Plate numbers marked red indicate no lever option

# Plate Door Furniture

## Lockwood 4800/5800 Series Plate Furniture

### Backset Suitability Chart

Based on 12mm doorstop

Lever Number	Handed	3580 23mm	4580 25.4mm	5580 30mm	6580 38mm
32	No	No	No	Yes	Yes
41	Yes	No	No	Yes	Yes
44	No	No	No	No	No
45	No	No	No	Yes	Yes
50	Yes	No	No	No	No
53	Yes	No	No	Yes	Yes
55	No	No	No	No	No
55A	No	No	No	Yes	Yes
59	No	No	No	Yes	Yes
62	No	No	No	Yes	Yes
70	No	Yes	Yes	Yes	Yes
71	No	No	No	Yes	Yes
74	No	No	No	Yes	Yes
78	No	No	No	Yes	Yes
79	No	No	No	No	No
79B	No	No	No	Yes	Yes
80	No	No	Yes	Yes	Yes
83	No	No	No	Yes	Yes
90	No	No	No	Yes	Yes
91	No	No	No	Yes	Yes
94	Yes	Yes	Yes	Yes	Yes
97	No	Yes	Yes	Yes	Yes

# Plate Door Furniture

## 200 Series Artefact Square Corner Plates

The 200 Series Door Furniture is 162mm square with square corners. Concealed fixed plates have studs with internal threads located in each corner, visible fixed plates have corresponding countersunk holes and are fixed back to back through the door.

### Application

Designed for use with Lockwood 3570 Series Mortice Locks; Latches and Push and Pull doors.

### Features and Specifications

#### Dimensions

162 x 162 x 3mm aluminium

162 x 162 x 2mm stainless steel and brass

#### Materials

Aluminium, brass and stainless steel

#### Door Thickness

35 to 45mm standard. For doors 45 to 55mm thick, specify long fixing screws SP2000 208.

**Note:** When using flush pulls back to back the minimum door thickness is 40mm.

### Finishes

#### Standard

Natural Anodised Aluminium NT  
Satin Stainless Steel SS

#### Non Standard

Polished Stainless Steel PS  
Powdercoat PC  
Marine Grade MG  
Polished Brass PB

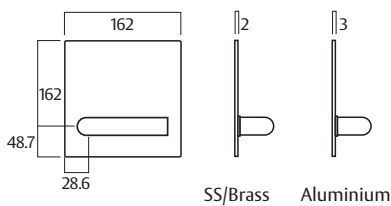

### Levers and Knob to Suit



Brass levers and knobs also available on stainless steel and brass plates refer page 3.100

\*Aluminium Only

### Pull Handle to Suit

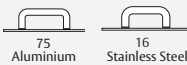

### Plates

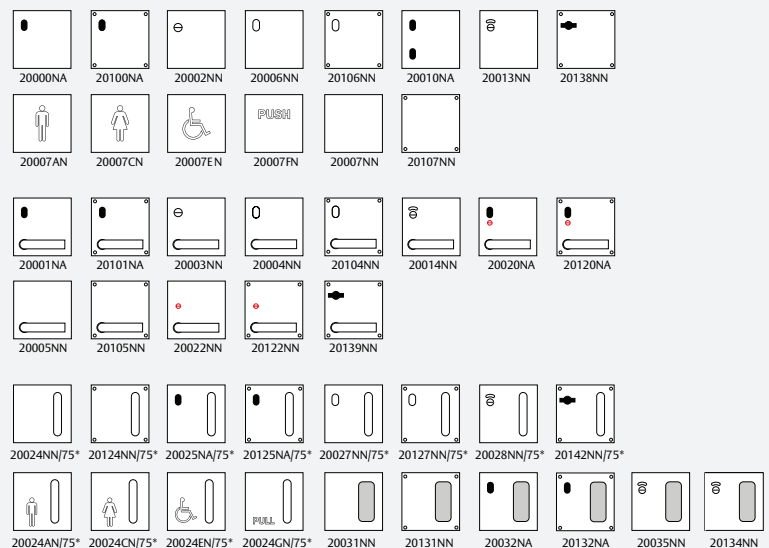

#### Legend

Cylinder Hole		Slotted Button		LED	
Turn Snib		Disabled		Indicating Slotted Button	



FIRE RATED



DURABILITY



HIGH SECURITY



ANTI-CORROSION



# Plate Door Furniture

## 202 Series Artefact 10mm Radius Corner Plates



The 202 Series Door Furniture is 162mm square with 10mm radius corners. Concealed fixed plates have studs with internal threads located in each corner, visible fixed plates have corresponding countersunk holes and are fixed back to back through the door.

### Application

Designed for use with Lockwood 3570 Series Mortice Locks; Latches and Push and Pull doors.

### Features and Specifications

#### Dimensions

162 x 162 x 3mm aluminium

162 x 162 x 2mm stainless steel and brass

#### Materials

Aluminium, stainless steel and brass.

#### Door Thickness

35 to 45mm standard. For doors 45 to 55mm thick, specify long fixing screws SP2000 208.

**Note:** When using flush pulls back to back the minimum door thickness is 40mm.

### Finishes

#### Standard

Natural Anodised Aluminium NT  
Stainless Steel SS

#### Non Standard

Polished Stainless Steel PS  
Powdercoat PC  
Marine Grade MG  
Polished Brass PB

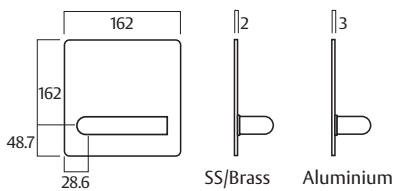

### Levers and Knob to Suit



Brass levers and knobs also available on stainless steel and brass plates refer page 3.100

\*Aluminium Only

### Pull Handle to Suit

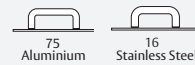

### Plates



### Legend

Cylinder Hole		Slotted Button		LED	
Turn Snib		Disabled		Indicating Slotted Button	



# Plate Door Furniture

## 212 Series Artefact Oval Plates

The 212 Series Door Furniture is 162mm long x 50mm wide with radius ends. Concealed fixed plates have studs with internal threads located top and bottom, visible fixed plates have corresponding countersunk holes and are fixed back to back through the door.

### Application

Designed for use with Lockwood 3570 Series Mortice Latches.

### Features and Specifications

#### Dimensions

162 x 50 x 3mm aluminium

162 x 50 x 2mm stainless steel and brass

#### Materials

Aluminium, stainless steel or brass.

#### Door Thickness

35 to 45mm standard. For doors 45 to 55mm thick, specify long fixing screws SP2000 208.

### Finishes

#### Standard

Natural Anodised Aluminium NT  
Stainless Steel SS

#### Non Standard

Polished Stainless Steel PS  
Powdercoat PC  
Marine Grade MG  
Polished Brass PB

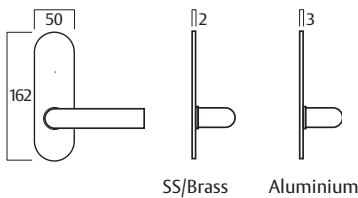

### Levers and Knob to Suit



Brass levers and knobs also available on stainless steel and brass plates refer page 3.100

\*Aluminium Only

### Pull Handle to Suit

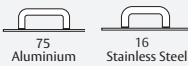

### Plates

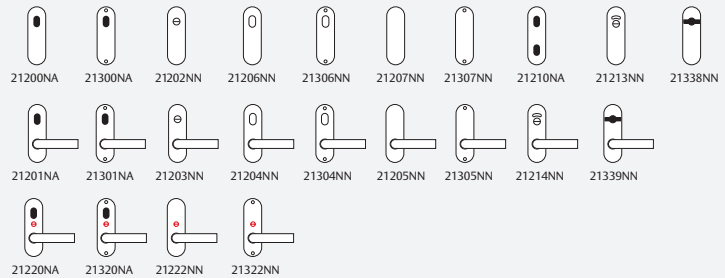

### Legend

Cylinder Hole		Slotted Button		LED	
Turn Snib		Disabled		Indicating Slotted Button	



FIRE RATED



D3 DURABILITY



S3 HIGH SECURITY



ANTI-CORROSION

# Plate Door Furniture

## 224 Series Artefact Rectangular Plates

The 224 Series Door Furniture is 162mm long x 50mm wide with square ends. Concealed fixed plates have studs with internal threads located top and bottom, visible fixed plates have corresponding countersunk holes and are fixed back to back through the door.

### Application

Designed for use with Lockwood 3570 Series Mortice Latches.

### Features and Specifications

#### Dimensions

162 x 50 x 2mm stainless steel

#### Materials

Stainless Steel only.

#### Door Thickness

35 to 45mm standard. For doors 45 to 55mm thick, specify long fixing screws SP2000 208.

### Standard Finishes

Stainless Steel SS

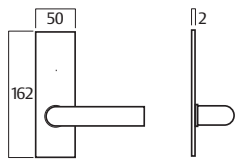

Stainless Steel

### Levers and Knob to Suit

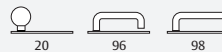

Brass levers and knobs also available refer page 3.100

### Pull Handle to Suit



16  
Stainless Steel

### Plates

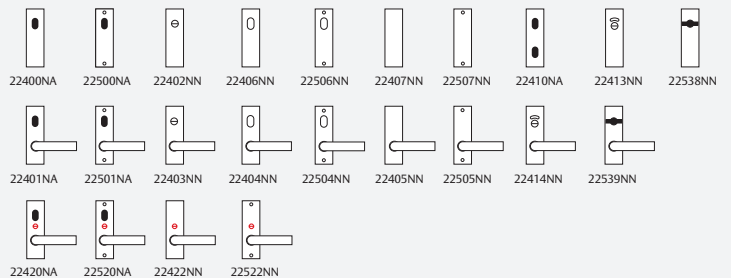

### Legend

Cylinder Hole		Slotted Button		LED	
Turn Snib		Disabled		Indicating Slotted Button	



FIRE RATED



DURABILITY



HIGH SECURITY



ANTI-CORROSION

# Plate Door Furniture

## Detention Series Furniture Square Plate

### Description

A heavy duty plate designed for use in hospitals and detention facilities. Styled for institutional use, this plate has six fixing points to ensure that it is well secured to the door. Plates are designed to be free of ligature points.

### Application

Lockwood 3570 Series Mortice Locks and Lockwood 3579 Secure Area Rated Locks.

### Features and Specifications

- Anti ligature
- Covers fixing holes from existing Artefact 200 Series Furniture
- Detention furniture turns feature a clutching mechanism that allows the cylinder to retract the bolt even if the turn knob is held from the inside.

### Dimensions

162mm x 180mm x 2mm: base plate

161mm x 75mm x 3mm: bevelled top plate

### Handing

All plates are handed except 220D07 and 220D31, which are non handed when ordered without engraving.

### Materials

Stainless steel

### Fixing

- Six fixing points
- 220D series plates have concealed fixings
- 221D series plates have visible fixings

### Door Thickness

35mm minimum, 45mm maximum

For thicker doors, longer screws are required.

**Note:** A minimum door thickness of 50mm is required to fit flush pulls back to back.

### Standard Finish

Satin Stainless Steel SS

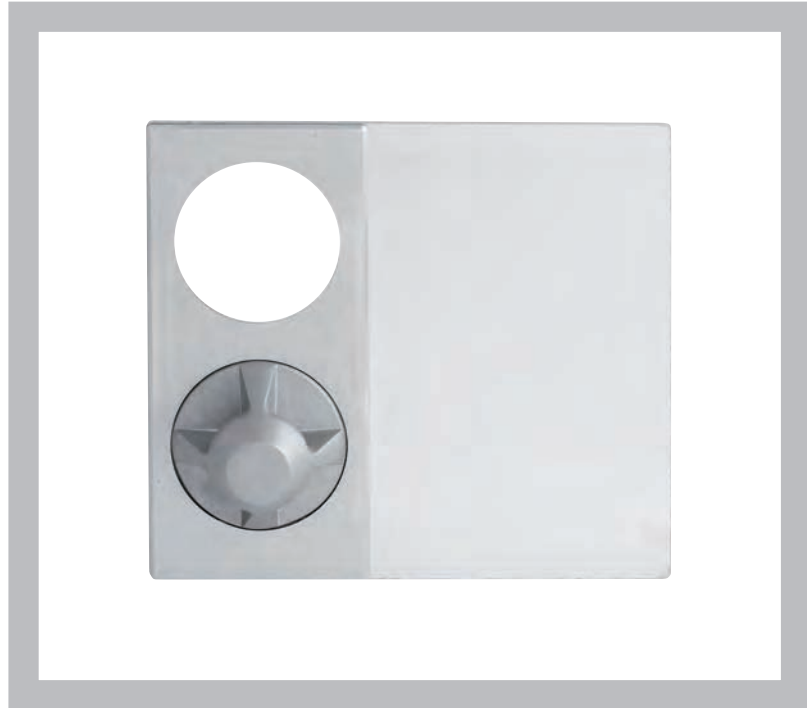

### Lever and Knob Selection

Standard Knob 21

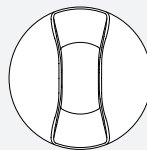

Webbed Knob 22



Lever 23

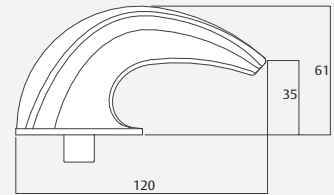
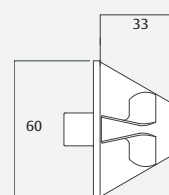
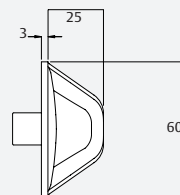
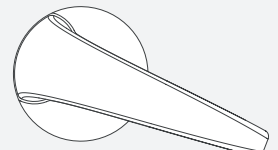

# Plate Door Furniture

## Detention Series Furniture Square Plate Functions

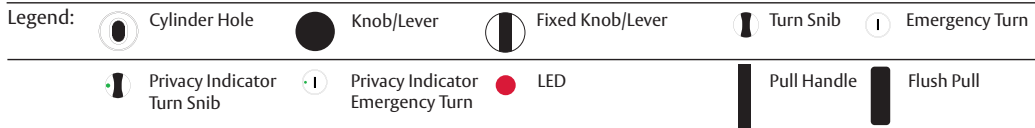
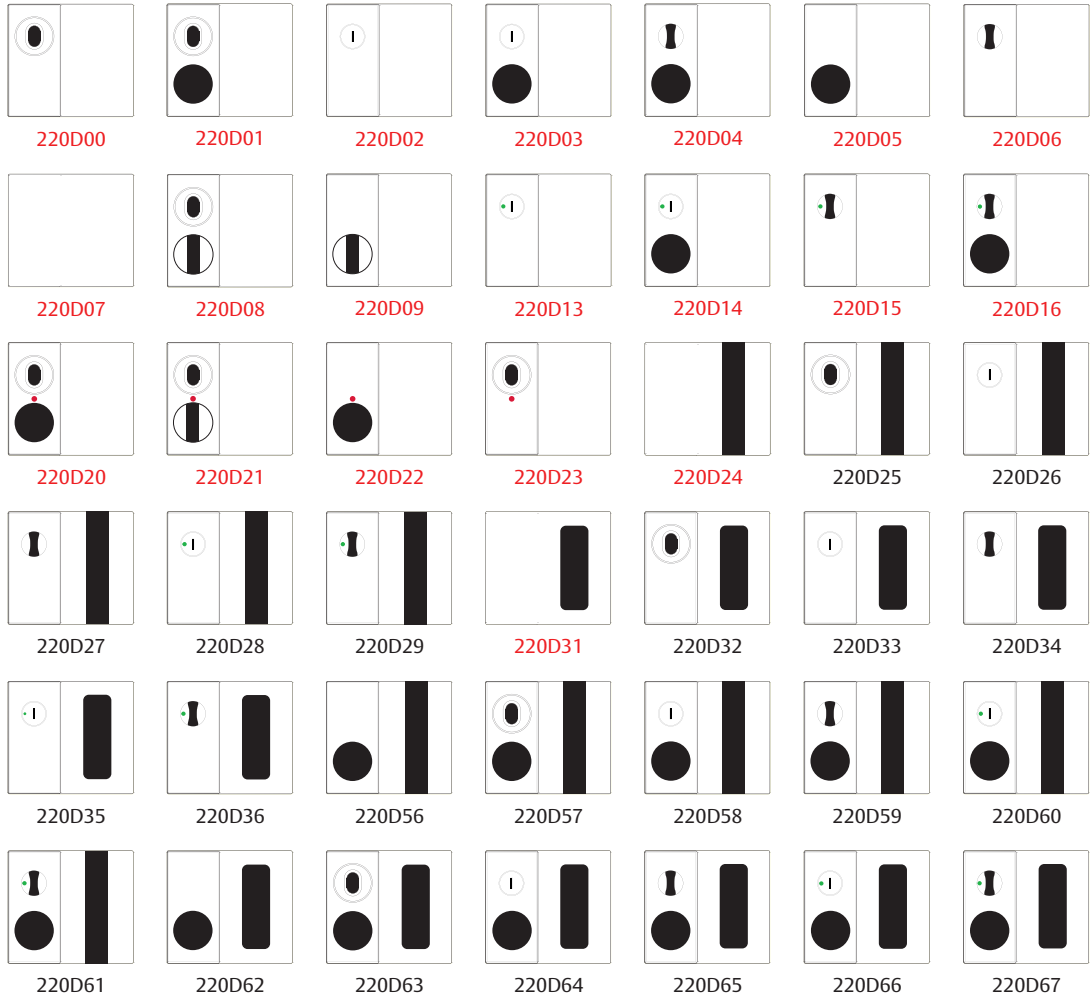

Cylinder guards must be ordered separately. Only the plate functions shown above in red are available with engraving.

# Plate Door Furniture

## Detention Series Furniture Rectangular Plate

### Description

This smaller plate range has been designed for use in detention facilities such as hospitals where domestic aesthetics are preferred over institutional type styling. Plates are designed to be free of ligature points.

### Application

Lockwood 3570 Series Mortice Locks and Lockwood 3579 Secure Area Rated Locks.

### Features and Specifications

- Anti ligature
- Covers fixing holes from existing 212 Series Artefact Plates
- Detention furniture turns feature a clutching mechanism that allows the cylinder to retract the bolt even if the turn knob is held from the inside.

### Dimensions

162mm x 76mm x 2mm: base plate

161mm x 75mm x 3mm: bevelled top plate

### Handing

Only plates with levers and/or turn knobs are handed.

### Materials

Stainless steel

### Fixing

- Four fixing points
- 222D series plates have concealed fixings
- 223D series plates have visible fixings

### Door Thickness

35mm minimum, 45mm maximum

For thicker doors, longer screws are required.

### Standard Finishes

Satin Stainless Steel      SS



### Lever and Knob Selection

Standard Knob 21

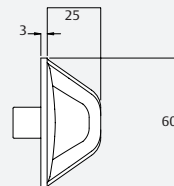
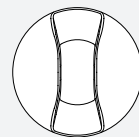

Webbed Knob 22

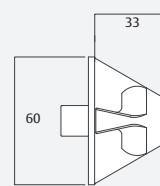
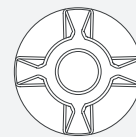

Lever 23

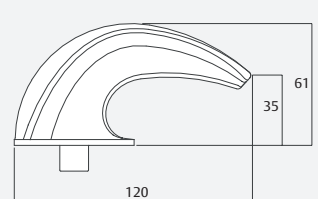
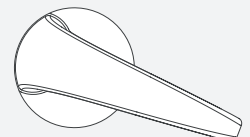

# Plate Door Furniture

## Detention Series Furniture Rectangular Plate Functions

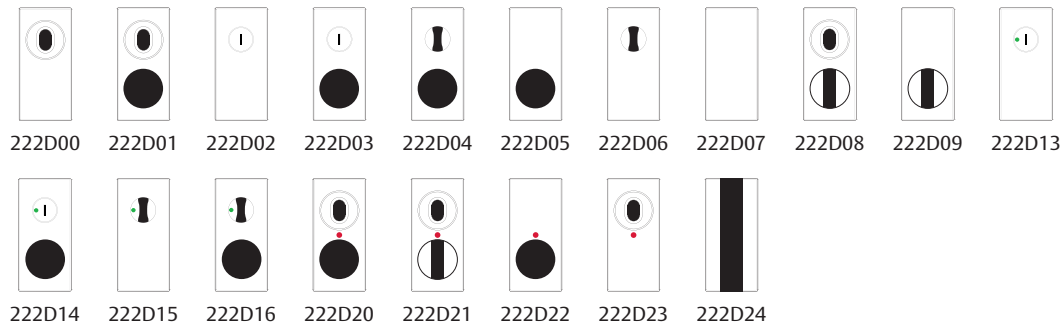

Legend:

	Cylinder Hole		Knob/Lever		Fixed Knob/Lever		Turn Snib		Emergency Turn
	Privacy Indicator Turn Snib		Privacy Indicator Emergency Turn		LED		Pull Handle		Flush Pull

**Note:** Only plates with levers and/or turn knobs are handed. 223D Series have visible fixings.



# Plate Door Furniture

## Detention Series Furniture Accessories

### Knobs and Lever

#### Standard Knob 21

Simple yet functional, this knob has soft edges to minimise impact injuries and anti ligature features that make it suitable for use in detention facilities.

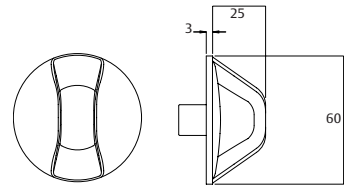

#### Webbed Knob 22

The webbed knob combines pleasing aesthetics, comfortable grip and anti ligature features to provide a solution for any environment.

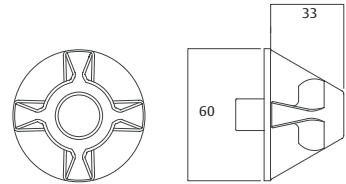

#### Detention Lever 23

Ergonomically designed to maximise grip, the detention lever is suitable for use in hospitals and minimum security applications. It caters especially for the elderly or people with arthritic conditions.

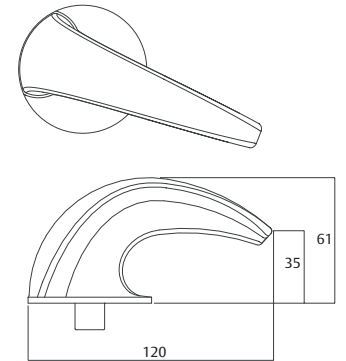

### Turns

#### Emergency Turn

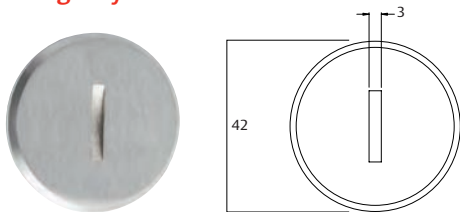

#### Turn Knob

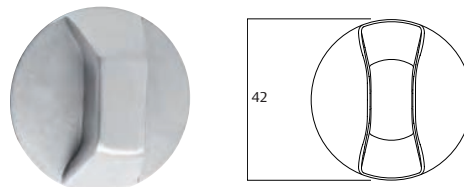

#### Indicating Emergency Turn

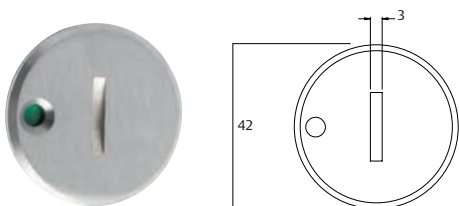

#### Indicating Turn Knob

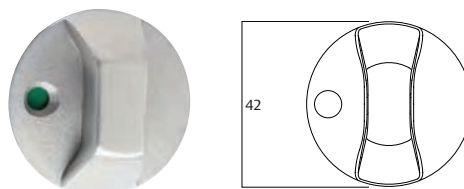



# Plate Door Furniture

## Detention Series Furniture Accessories

### Pulls

#### Flush Pull

The detention flush pull has been designed to maximise grip and eliminate the possibility of hiding objects in the cavity.

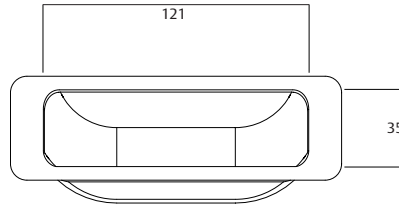

#### Standard Pull

The detention pull allows for a firm grip and can be used to open heavy doors. Also designed to be free of hanging points.

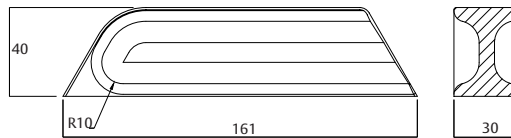

### Cylinder Guards

#### Description

Cylinder guards must be fitted with any cylinder plate function. Guards are available to suit different door thicknesses.

Part Number	Door Thickness Suitability
220D00/40SS	Suit doors 35 40mm
220D00/45SS	Suit doors 40 45mm
220D00/50SS	Suit doors 45 50mm
220D00/55SS	Suit doors 50 55mm
220D00/60SS	Suit doors 55 60mm



### Fixing Screws

Torx anti tamper, snake eye and standard screws are available in accessory packs to suit different door thicknesses. Only standard screws to suit doors 35mm 45mm thick are supplied with furniture. Other variations need to be ordered separately using part numbers specified.

All accessory packs contain six screws.

Part Number	Description	Door Thickness Suitability
220D11/45	Torx Anti tamper Screws	35 45mm
220D11/55	Torx Anti tamper Screws	45 55mm
220D11/65	Torx Anti tamper Screws	55 65mm
220D12/45	Standard Screws	35 45mm
220D12/55	Standard Screws	45 55mm
220D12/65	Standard Screws	55 65mm
220D13/50	Snake eye Screws	35 50mm

# Plate Door Furniture

## Palladium Series Overview

The exceptional range of Palladium Door Furniture offers builders, specifiers and interior designers an array of levers that can be used in any residential environment.

The Palladium Series of door furniture reflects the best in quality, blended with sophisticated designs. The Palladium Series was produced to meet the rigorous aesthetic requirements of residential markets, while conforming to the ever increasing need for quality semi commercial building segments.

Available in Palladium and Palladium Xtra versions to suit a wide range of applications.



Summit L1



Spire L2



Element L3



Glide L4



Aria #27



Hakea #28



Acacia #29



Saltbush #34



Mulga #36



Gidgee #37

# Plate Door Furniture

## Palladium Series Door Furniture



The Palladium Series represents the highest standard in residential and semi commercial door hardware and is brought to you through modern innovative designs, combined with quality manufacturing. A wide range of lever options is available to enable a common style throughout the home.

### Features and Specifications

#### Dimensions

222 x 30 x 9mm

#### Handing

Easy, field selectable handing.

#### Materials

All plates and levers in the Palladium Series are constructed from solid zinc die cast.

#### Fixing

Lockwood Palladium Series Door Furniture is a complete set, supplied with both the internal and external plates. Plates are designed to fit back to back to be fully concealed externally.

#### Door Thickness

Minimum 32mm maximum 45mm door thickness.

#### Keying

Use with Euro profile cylinder.

#### Finishes

Satin Chrome Pearl	SP
Chrome Plate	CP
Gold Plate	GLD
Black	BLK
Polyester Powdercoat (Specify Dulux Color)	PPC

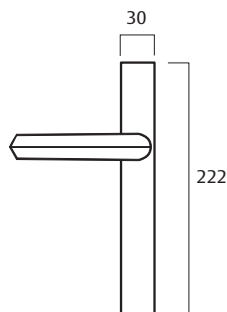

### 85mm Plates and Functions

For use with Optimum Mortice Locks.

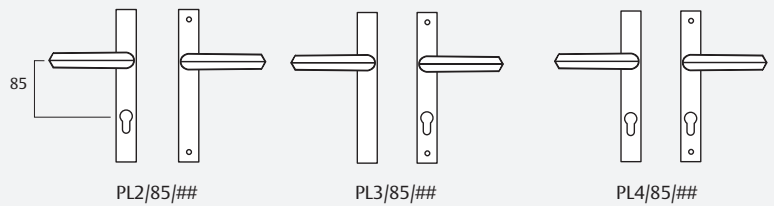

Note: The internal single cylinder configuration is also used in the Palladium French Door kits (PLFD/85/##) only in this configuration the external lever is fixed.

### No Pitch Plates

For use with passage functions.

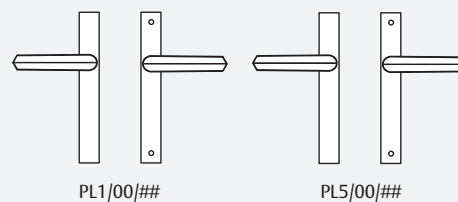

## Represents lever style number.

# Plate Door Furniture

## Palladium Xtra Furniture

The Palladium Xtra Series is designed specifically for the Optimum range of mortice locks to increase functionality enabling both internal snibbing for safety mode and lock status indication.

Palladium Xtra is suitable for use in residential buildings, apartments and semi commercial applications.

### Features and Specifications

#### Dimensions

222 x 30 x 9mm

#### Handing

Easy, field selectable handing.

#### Materials

All plates and levers in the Palladium Series are constructed from solid zinc die cast.

#### Fixing

Lockwood Palladium Xtra door furniture is a complete set, supplied with both the internal and external plates. Plates are designed to fit back to back to be fully concealed externally.

#### Door Thickness

Minimum 32mm maximum 45mm door thickness.

#### Keying

Use with Euro profile cylinder.

#### Finishes

Satin Chrome Pearl	SP
Black	BLK
Chrome Plate	CP
Polyester Powder Coat	PPC



### 85mm Plates and Functions

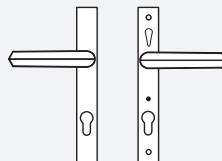

PX4/85/##

## Represents lever style number.

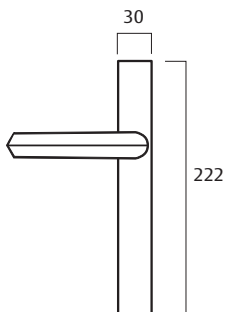

# Plate Door Furniture

## Palladium Series Door Furniture



ASSA ABLOY

**Summit L1**

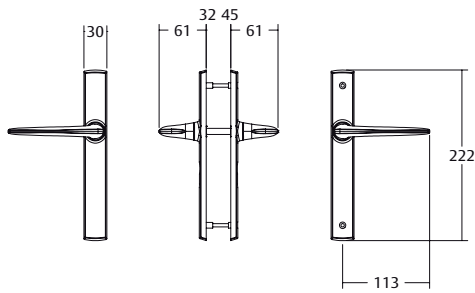

**Hakea #28**

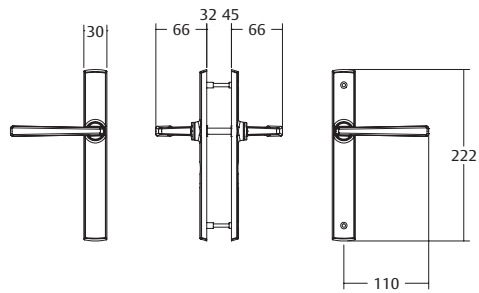

**Spire L2**

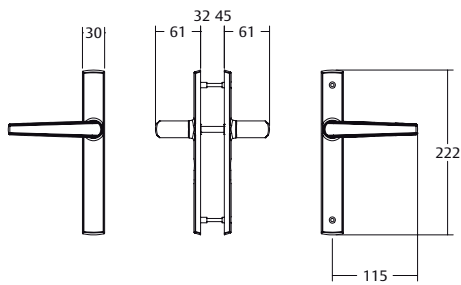

**Acacia #29**

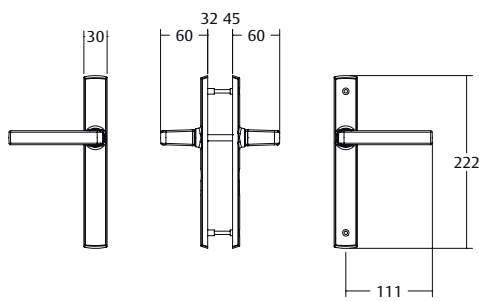

**Element L3**

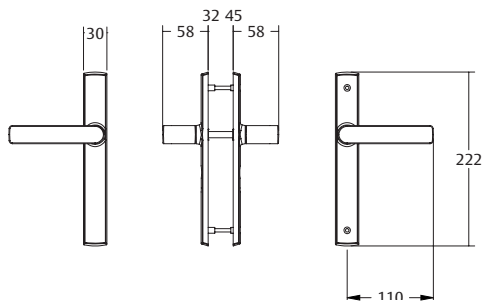

**Saltbush #34**

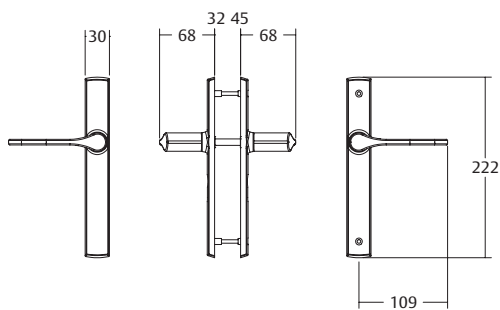

**Glide L4**

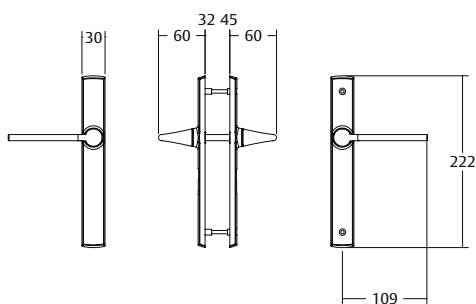

**Mulga #36**

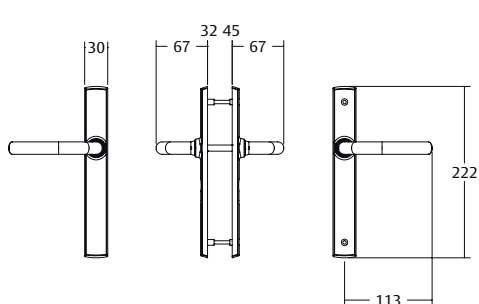

**Aria #27**

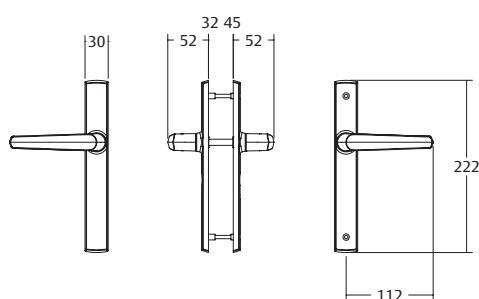

**Gidgee #37**

